

LBS-3232

LINK BRIDGE™ UNIVERSAL 32X32 OPTICAL/DVI/HDMI MATRIX SWITCH



BCI reserves the right to make changes to the products described herein without prior notice or consent. No liability is assumed as a result of their use or application. All rights reserved.

©2013 Broadata Communications, Inc.



SAFETY INSTRUCTIONS AND COMPLIANCE DECLARATIONS

PLEASE OBSERVE THE FOLLOWING SAFETY PRECAUTIONS AS OUR
PRODUCTS CONTAIN
CLASS I LASER PRODUCTS

WARNING

This product is a **CLASS I LASER PRODUCT** only when the units are connected with a fiber optical cable. Do not disconnect the fiber optic connector while the unit is powered up. Exposure to laser radiation is possible when the laser fiber optic connector is disconnected while the unit is powered up. It should be noted that when the fiber is disconnected, the product will have **CLASS IM INVISIBLE LASER RADIATION**.

Although the fiber optic connectors in this product emit only Class 1 energy that is below the levels considered to be hazardous, one should never stare directly into a fiber optic connector or an unconnected fiber end unless one can be certain that no exposure to laser energy could occur.



CAUTION

Only service personnel are intended to access the interior of the units. It should be cautioned that **CLASS 3 INVISIBLE LASER RADIATION WHEN OPEN, AVOID EXPOSURE TO THE BEAM**. The use of controls, making adjustments, or performing operations other than those specified may result in hazardous radiation exposure. This product has operating wavelengths at 778nm, 800nm with average -0.5dB to 0dBm optical power per wavelength, 825nm, 911nm, and 980nm. The laser is operated in pulse mode within 1 KHz frequency and ¼ duty cycle.

The following label or equivalent is located on the surface of laser products. This label indicates that the product is classified as a **CLASS 1 LASER PRODUCT**.

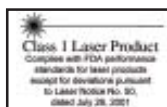

SURGE PROTECTION DEVICE RECOMMENDED

This product contains sensitive electrical components that may be damaged by electrical spikes, surges, electric shock, lightning strikes, etc. Use of surge protection systems is highly recommended in order to protect and extend the life of your equipment.

TABLE OF CONTENTS

1.0	PRODUCT DESCRIPTION	5
2.0	OPERATION CONTROLS AND FUNCTIONS	6
2.1	FRONT PANEL	6
2.2	REAR PANEL	8
3.0	SWITCH CONTROL	9
3.1	RS-232 PIN ASSIGNMENT	9
3.2	RS-232 AND TELNET COMMANDS	10
3.3	TELNET CONTROL	11
3.4	WEB GUI CONTROL	13
4.0	SPECIFICATIONS	15
5.0	SERVICE PROCEDURE	17
5.1	REPLACEMENT POLICY	17
5.2	RETURN AND REPAIR SERVICE	17
6.0	LIMITED WARRANTY	18
7.0	APPENDIX	19

1.0 PRODUCT DESCRIPTION

The LBS Series is a high performance Link Bridge™ Universal Matrix Switcher System that provides up to 32x32 video switching for HDMI/DVI signals. It supports 12-bit deep color resolutions up to 1080p and 1920x1200@60Hz with multi-channel digital audio, such as LPCM 7.1CH, Dolby TrueHD, Dolby Digital Plus and DTS-HD. Standard versions of the LBS support all optical switching, or hybrid optical/electrical switching, for HDMI/DVI signals. When configured for optical switching, only one fiber is required per input or output port. In addition, the distance between the switch and HDMI/DVI devices can be up to 400m when connected by fiber cable. The I/O ports in the LBS can be configured in multiples of 8, thus supporting 8x8, 8x16, 24x16, up to 32x32 matrix size. The LBS comes in a 5-RU packaging design, and has option for single or dual power supply.

The LBS supports jitter-free, high-quality HDMI/DVI Display with several EDID functions for independent display resolution at per-port basis. Types of switching control available: manual control panel, standard RS-232, or Ethernet Web GUI and Telnet control.

2.0 OPERATION CONTROLS AND FUNCTIONS

2.1 Front Panel

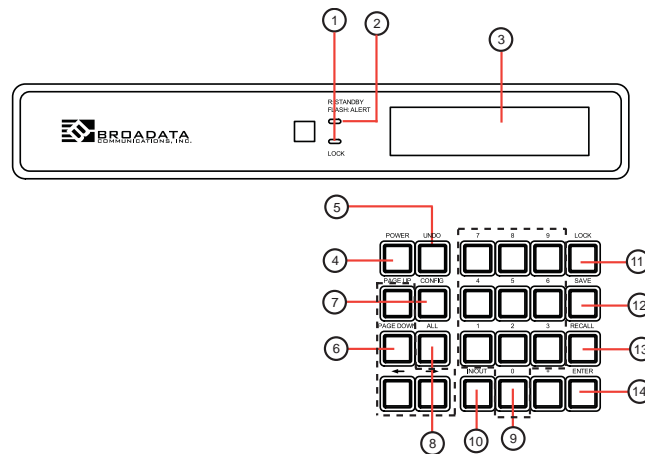

- 1 **LOCK LED:** This LED will illuminate when the on-panel key functions is set to lock.
- 2 **POWER LED:** This red LED will illuminate when the device is set to standby mode, when it is flashing it means the temperature inside is too high and air circulation is highly suggested.
- 3 **LCD:** Displays the setting information of each input and output and other setting information according to the selection.
- 4 **POWER:** Press this button to turn on the device or to set it to standby mode.
- 5 **UNDO:** Press this button to return back/exit the current selection.
- 6 **PAGE UP, PAGE DOWN, ◀, ▶:** Use these buttons to flip the LCD's page for displaying the current I/O status or when entering into the menu for detail selection.

- 7 **CONFIG:** Press this button to enter into the menu selections of
 - A. EDID Setting
 - Standard EDID: Use the built-in EDID which supports video up to 1080p@60/WUXGA@60Hz.
 - Auto EDID: based on the TV/Display's EDID of the lowest connected output port.
 - Manual EDID: Support independent EDID by assigning the selected input port to the selected output port.
 - B. IP Configuration
 - 1. IP address,
 - 2. Netmask,
 - 3. Gateway.
 - C. Temperature
 - T1, T2: these figures shows the temperature inside the device.
 - D. LCD Contrast Range from 1~4
- 8 **ALL:** Press this button to select all outputs to one input.
- 9 **0~9:** Press these numbers when selecting input output ports.
- 10 **IN/OUT:** Press this button to select input source to display on output display. The sequence should be IN/OUT-number of input source-IN/OUT-number of output display-Enter. (This button works only under In/Out function)
- 11 **LOCK:** Press this button to lock all the function buttons on panel. To unlock, press and hold lock button for 4 seconds.
- 12 **SAVE:** Press this button to save the present setting of the I/O. There are 10 pre-sets available for saving.
- 13 **RECALL:** Press this button to recall from the saving settings of 1~10.
- 14 **ENTER:** Press this button every time to confirm the setting or the selection.

2.2 Rear Panel

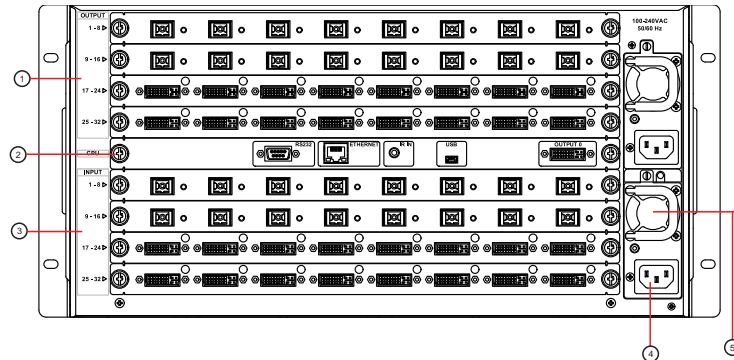

- 1 **OUTPUT 1~32:** Connect HD/3D display TV/monitor with HDMI cables up to 32 displays.
- 2 **CPU**
 - a. USB: This port is reserved for firmware update only.
 - b. IR IN: Reserved.
 - c. ETHERNET: Connect to an active network line for LAN and Telnet/Web GUI control.
 - d. RS-232: Connect with D-Sub 9-pin cable from the PC/Control device for RS-232 control over the LBS-3232.
- 3 **INPUT 1~32:** Connect source equipment such as Blu-ray/PS3 players up to 32 devices with HDMI/optical cable.
- 4 **POWER & POWER Supply:** The device will automatically be placed on stand-by mode when the power supply is connected to AC power.
- 5 **Ventilation Fan:** This fan will automatically turn on when the device is switched ON. Do not block this port of the device or cover it with any object. Please allow adequate space around the unit for air circulation.

3.0 SWITCH CONTROL

3.1 RS-232 Pin Assignment

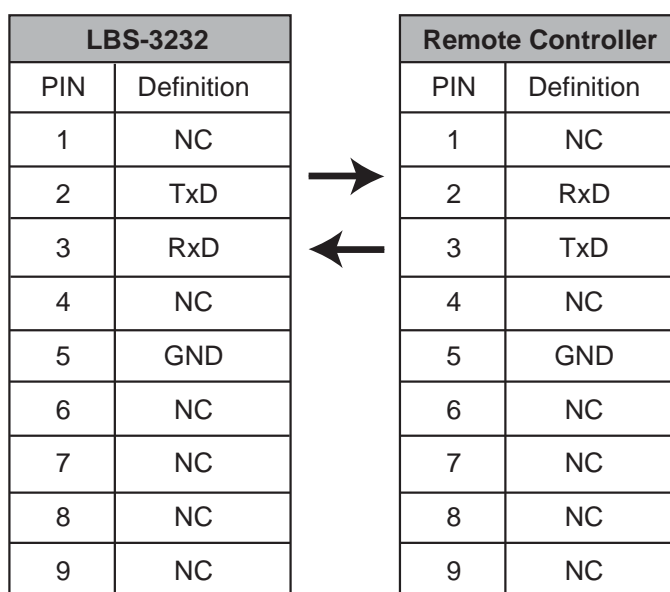

Default Port Settings
Baud Rate: 19.2K
Data Bits: 8
Parity Bits: None
Stop Bits: 1
Flow Control: None

3.2 RS-232 and Telnet Commands

Refer to Appendix A for full list of commands.

3.3 Telnet Control

Before attempting to use the telnet control, please ensure that both the Matrix (via the 'LAN/CONTROL' port) and the PC/Laptop are connected to the active networks.

Note: Please do not connect both the Matrix and the PC/Laptop with a single CAT5e/6 cable together as it will not access the telnet function.

To access the telnet control in Windows 7, click on the 'Start' menu and type "cmd" in the Search field then press enter.

Under Windows XP go to the 'Start' menu and click on "Run", type "cmd" with then press enter.

Under Mac OS X, go to Go-Applications-Utilities-Terminal. See below for reference.

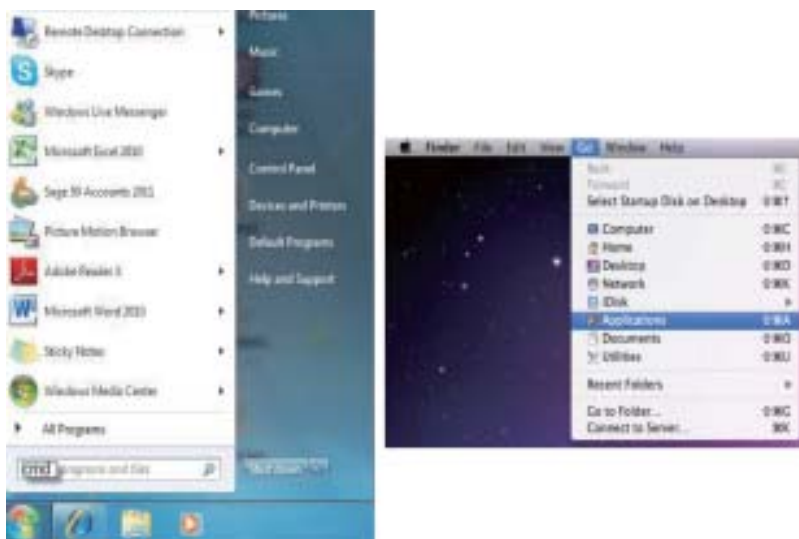

Once in the command line interface (CLI) type “telnet”, the IP address of the unit you wish to control, then hit enter.

Note: The IP address of the Matrix can be displayed on the device's LCD monitor by pressing the “Config” button twice, then ENTER.



This will bring us into the device which we wish to control. Type “HELP” to list the available commands.

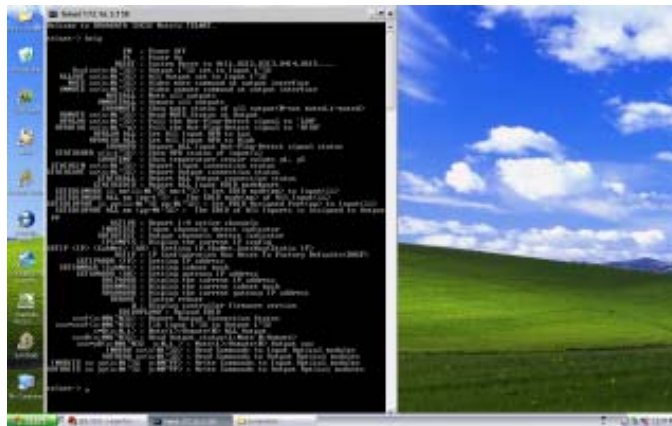

Type “IPCONFIG” To show all IP configurations. To reset the IP, type “RSTIP” and to use a set static IP, type “SETIP” (For a full list of commands, see Appendix A).

Note: Commands will not be executed unless followed by a carriage return. Commands are not case-sensitive. If the IP is changed then the IP Address required for Telnet access will also change accordingly.

3.4 Web GUI Control

On a PC/Laptop that is connected to the same active network as the Matrix, open a web browser and type device's IP address on the web address entry bar. The browser will display the device's status, control and User setting pages.

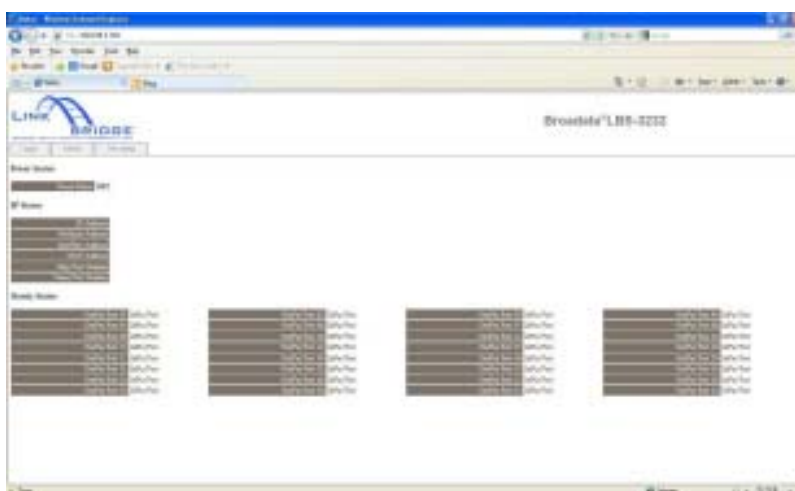

Click on the 'Control' tab to control power, input/output ports, EDID and reset mode.

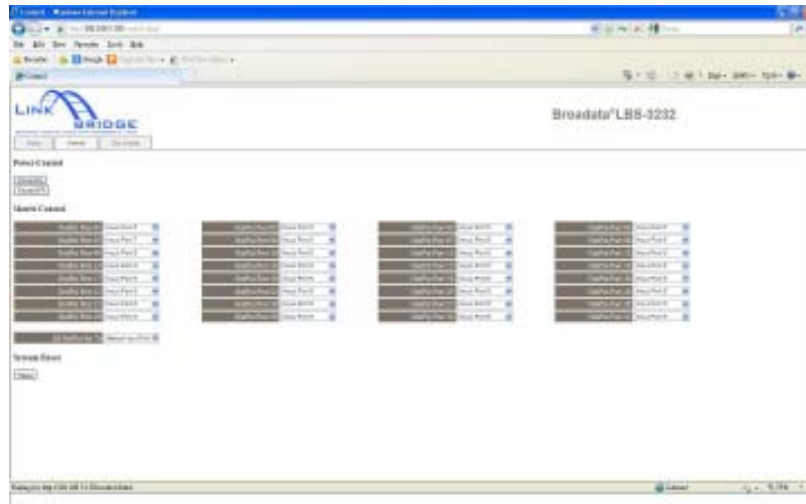

Clicking on the 'User Setting' tab allows you to reset the IP configuration. The system will ask for a reboot of the device every time any of the settings are changed. The IP address needed to access the Web GUI control will also need to be changed accordingly on the web address entry bar.



4.0 SPECIFICATIONS

Matrix Switch

Array Size	Up to 32x32 (configurable by multiple of 8)
EDID Control	Built-in Internal Standard EDID

HDMI/DVI Ports*

Signal	Single Link DVI 1.1, HDMI 1.3
Resolution	Up to 1080p or 1920x1200@60Hz
Connector	DVI or HDMI Female Plugs
Protocol	EDID/DDC and HDCP Capable

Fiber Ports

Fiber Type	Multimode 50um or 62.5um
Connector	SC
Protocol	EDID/DDC and HDCP Capable

Control

Manual	Panel Button
RS-232	DB-9, 19.2 kb/s
Ethernet	10/100Base-T for Web Browser, Telnet

Physical

Dimension (H x W x D)	8.7" x 19.0" x 12", Including chassis handle
Power Level	110 VAC~240VAC, 50/60Hz 450W (max.) with all optical ports 250W (max.) without optical ports
Operating Temperature	0 to +40°C
Humidity	0 to 90% RH, non-condensing

5.0 SERVICE PROCEDURE

5.1 Replacement Policy

Standard products found defective on arrival (DOA) will be replaced, based on availability, within 24 to 48 hours anywhere in the U.S. Please call Customer Service at **800-214-0222** for information.

5.2 Return/Repair Service

The LBS-3232 System contains no user serviceable components. If you have a problem with your unit, please contact the Customer Service Department. To facilitate our return/repair processing please contact Broadata Communications, Inc. to obtain a Return Material Authorization (RMA). Please include the following information:

- Product model number
- Serial Number
- Complete description of problem
- Hardware installation description

Broadata Communications, Inc.
2545 West 237th Street, Suite K
Torrance, CA 90505
1-800-214-0222
(310) 530-1416
(310) 530-5958 (Facsimile)
e-mail: CustomerService@Broadatacom.com
Website: www.broadatacom.com

6.0 LIMITED WARRANTY

Broaddata Communications, Inc. (BCI) warrants, for a period of one year from date of shipment, each product sold shall be free from defects in material and workmanship. BCI will correct, either by repair, or at BCI's election, by replacement, any said products that in our sole discretion prove to be defective and are returned to the manufacturing location within 30 days after such defect is ascertained. All warranties are limited to defects arising under normal use and do not include malfunctions or failure resulting from misuse, abuse, neglect, alterations, electrical power problems, usage not in accordance with product instructions, improper installation, or damage determined by BCI to have been caused by the Buyer or repair made by a third party. Limited warranties granted on products are to the initial customer end-user and are not transferable. OUR LIABILITY UNDER THIS WARRANTY SHALL IN ANY CASE BE LIMITED TO THE INVOICE VALUE OF THE PRODUCT SOLD AND BCI SHALL NOT BE LIABLE TO ANYONE FOR CONSEQUENTIAL OR INCIDENTAL DAMAGES ARISING FROM THE USE OF ITS PRODUCTS OR THE SALE THEREOF. We make NO WARRANTY AS TO THE MERCHANTABILITY OF ANY GOODS, OR THAT THEY ARE FIT FOR ANY PARTICULAR PURPOSE OR END APPLICATION NOR DO WE MAKE ANY WARRANTY, EXPRESSED OR IMPLIED OTHER THAN AS STATED ABOVE.

7.0 APPENDIX A

Appendix A: LBS Command List

BCI Commands	BCI Serial Command Response	Description
P0	POWER OFF	Power Off
P1	POWER ON	Power On
RESET	O01101 O02102 O03103 O04104 O05105 O32132 O00101 Unmute ALL Output. Set HPD HIGH to ALL Input. Set EDID Mode to INTERNAL. Set HDCP Enable. ALL OUTPUTS RS232 BAUD RATE 19200 ARE SET	System Reset to O111, O212, O313, O414, O515.... Unmute ALL Output. Set HPD HIGH to ALL Input. Set EDID Mode to INTERNAL. Set HDCP Enable. ALL OUTPUTS RS232 BAUD RATE 19200 ARE SET
Oxxlyy (x,y:1-32)	Oxxlyy	Output xx set to Input yy
ALLOUT x (x:1-32)	alout x	All Output set to Input x
HDCPONALL	ALL INPUTS HDCP ARE ENABLED	Setting all Input port HDCP on.
HDCPOFFALL	ALL INPUTS HDCP ARE DISABLED	Setting all Input port HDCP off.
HDCPON xx(x:01-32)	INPUT xx HDCP IS ENABLED	Setting Input port HDCP on.
HDCPOFF xx(x:01-32)	INPUT xx HDCP IS DISABLED	Setting Input port HDCP off.
SHOWHDCP	HDCP status (1=Enable, 0=Disable) 1	Show HDCP status of all output(0=HDCP disable,1=enable)
MUTEIN xx(x:0-32)	Mute Input x	Video mute at input interface
UNMUTEIN xx(x:0-32)	Unmute Input x	Video unmute at input interface
MUTEOUT x (x: 0-32)	Mute Output x	Video mute command at output interface.
UNMUTEOUT x (x: 0-32)	Unmute Output x	Video unmute command at output interface.
MUTEALL	Mute All Output.	Mute all Output
UNMUTEALL	Unmute All Output.	Unmute all Output
SHOWMUTE	O00=0, O01=0, O02=0, O03=1, O04=0, O05=0, O06=0, O07=0, O08=0, O09=0, O10=0, O11=0, O12=0, O13=0, O14=0, O15=0, O16=0, O17=0, O18=0, O19=0, O20=0, O21=0, O22=0, O23=0, O24=0, O25=0, O26=0, O27=0, O28=0, O29=0, O30=0, O31=0, O32=0	Show mute status of all output: 1=mute/on, 0=mute/off
RDMUTE x (x: 0-32)	Mute OFF.	Read MUTE Status at Output.
HPDLOW x(x:1-32)	Set lxx HPD to Low	Pull the Hot-Plug-Detect signal to 'LOW.'
HPDHIGH x(x:1-32)	Set lxx HPD to High	Pull the Hot-Plug-Detect signal to 'HIGH.'
HPDLOW ALL	Set all HPD to low	Set all input HPD to low.
HPDHIGH ALL	Set all HPD to High	Set all input HPD to high.

SHOWHPD	I1 HPD HIGH I2 HPD HIGH I3 HPD LOW I4 HPD HIGH I5 HPD HIGH I32 HPD HIGH	Report ALL Input Hot-Plug-Detect signal status
STATUSHPD x(x:1-32)	Ix HPD HIGH	Show HPD status of input(x)
SHOWTEMP	T1: 37.64 C T2: 36.192 C	Show temperature sensor values y1, y2
STATUSIN x (x:1-32)	Oxx	Report input connection status.
STATUSOUT x (x:1-32)	Iyy	Report output connection status.
STATUSALL	Input x is tied to output 1 ... Input y is tied to output 32	Report ALL Output connection status
STATUSEDID	EDID mode:(1)INTERNAL (2)AUTO (3)MANUAL I01:1 I02:1 I03:1 I04:1 I05:1 I06:1 I07:1 I08:1 I09:1 I10:1 I11:1 I12:1 I13:1 I14:1 I15:1 I16:1 I17:1 I18:1 I19:1 I20:1 I21:1 I22:1 I23:1 I24:1 I25:1 I26:1 I27:1 I28:1 I29:1 I30:1 I31:1 I32:1 EDID assigned Port: I01:01 I02:02 I03:03 I04:04 I05:05 I06:06 I07:07 I08:08 I09:09 I10:10 I11:11 I12:12 I13:13 I14:14 I15:15 I16:16 I17:17 I18:18 I19:19 I20:20 I21:21 I22:22 I23:23 I24:24 I25:25 I26:26 I27:27 I28:28 I29:29 I30:30 I31:31 I32:32	Report ALL Input EDID mode&port
SETEDIDMODE i mm(i:01-32 mm:1-3)	set "INTERNAL" for EDID mode of Input Port i.	Set EDID mode<mm> to input <i>, mm=1/2/3 for Standard/Auto/Manual.
SETEDIDMODE ALL mm (mm=1-3)	set "INTERNAL" for EDID mode of all Input Port.	Set EDID mode<mm> to all input, mm=1/2/3 for Standard/Auto/Manual.
SETEDIDPORT ii pp (i=01-32, pp=01-32)	The EDID of In Port ii is assigned to Out Port pp	Set EDID assigned port <pp> to input <i> when in manual EDID mode.
SETEDIDPORT ALL pp (pp=01-32)	The EDID of all In Port is assigned to Out Port pp.	The EDID of all imports is assigned to output <pp> when manual EDID mode.
ACTIVE	Report I/O active channels: IN: Iyy,Iyy OUT: Oxx,Oxx,Oxx	Report I/O active channels.
INDETECT	Input channels detect indicator: IN: Iyy,Iyy	Input channels detect indicator.
OUTDETECT	Output channels detect indicator: OUT: Oxx,Oxx,Oxx	Output channels detect indicator.
UARTSTR x "str"	Write UART string to output port(x:1-32)	
UARTBR x y	OUTPUT x RS232 BAUD RATE y IS SET	Setting output port(x:1-32) UART baud rate(y).
IPCONFIG	IP: 172.16.3.154 SUBNET: 255.255.255.1 GATEWAY: 172.16.3.1 MAC Address: 0e-12-00-aa-7a-f1	Display the current IP config.

SETIP <IP> <SubNet> <GW>	IP: 172.16.3.154 Netmask: 255.255.255.1 Gateway: 172.16.3.1	Setting IP,SubNet,GateWay (Static IP).
RSTIP	IP Configuration Was Rest To Factory Defaults(DHCP). Please Reboot The Unit.	IP Configuration Reset To Factory Defaults(DHCP).
SETIPADDR <IP>	Please Reboot The Unit.	Set IP address.
SETSNMASK <SubNet>	Please Reboot The Unit.	Set subnet mask.
SETGWADDR <GW>	Please Reboot The Unit.	Set gateway IP address.
RDIPADDR	IP: 172.16.3.154	Display the current IP address.
RDSNMASK	SUBNET: 255.255.255.1	Display the current subnet mask.
RDGWADDR	GATEWAY: 172.16.3.1	Display the current gateway IP address.
REBOOT	Unit Will Reboot Shortly.	System reboot.
PSSAVE x (x=1-10)	SAVE SETTING TO x	Save as Preset x (x=1-10).
PSRECALL x (x=1-10)	RECALL SETTING NO. x	Recall Preset x (x=1-10).
BUZZER x (x=0,1)	Buzzer mute	Buzzer Mute(0),UnMute(1)
Q	V2.0 W 15 Sep 2 2013	Display controller firmware version.
XXXI (X:1-32)	Input x is tied to the output.	Report Output Connection Status
XXX*XXXI (X:1-32)	Tie input x to Output x.	Tie input 1-32 to Output 1-32
X*B (X:0,1)	Mute all outputs.	Mute(1)/Unmute(0) ALL Output
XXXB (X:1-32)	mute off.	Read Output status(1:Mute 0:Unmute)
XXX*YB (X:1-32, Y:0,1)	Mute output x.	Mute(1)/Unmute(0) Output x
INREAD x (x=01-32)	IN x GPIO = yy	Read commands to input optical modules
OUTREAD x (x=01-32)	OUT x GPIO = yy	Read commands to output optical modules
INWRITE xx yy (xx=01-32, yy=00-FF)	WRITE yy to IN xx	Write commands to input optical modules
OUTWRITE xx yy (xx=01-32, yy=00-FF)	WRITE yy to OUT xx	Write commands to output optical modules

Broadata Communications, Inc.
2545 West 237th Street, Suite K
Torrance, CA 90505
1-800-214-0222
(310) 530-1416
(310) 530-5958 (Facsimile)
e-mail: Sales@Broadatacom.com
Website: www.broadatacom.com



60000-LBS-3232